

white light version

product family	FKDH 14	FKDK 14	FKDR 14
			
type	diffuse contrast sensor	diffuse contrast sensor	diffuse contrast sensor
width / diameter	19,6 mm	14,8 mm	19,6 mm
sensing distance T_w	12,5 mm \pm 2 mm	12,5 mm \pm 2 mm	12,5 mm \pm 2 mm
response time / release time	< 0,05 ms	< 0,05 ms	< 0,05 ms
light source	white LED	white LED	white LED
sensitivity adjustment	Teach-in	Teach-in	Teach-in
output circuit	push-pull	push-pull	push-pull
connection types	cable flylead connector	cable connector	connector
housing material	metal	plastic	metal
page	426	428	430

laser version

product family	OZDK 10	OZDK 10	OZDK 14	OZDM 16	OZDM 16
					
type	diffuse contrast sensor	diffuse contrast sensor	diffuse contrast sensor	diffuse contrast sensor	diffuse contrast sensor
width / diameter	10,4 mm	10,4 mm	14,8 mm	15,4 mm	15,4 mm
sensing distance T_w	3 ... 150 mm	3 ... 150 mm	20 ... 300 mm	0 ... 250 mm	0 ... 250 mm
response time / release time	< 0,05 ms	< 0,05 ms	< 0,15 ms	< 0,1 ms	< 0,05 ms
light source	pulsed red laser diode	pulsed red laser diode	pulsed red laser diode	pulsed red laser diode	pulsed red laser diode
sensitivity adjustment	potentiometer, 5 turn	potentiometer, 5 turn	Teach-in	potentiometer, 14 turn	potentiometer, 14 turn
output circuit	NPN PNP	NPN PNP	NPN PNP	PNP	NPN PNP
connection types	cable connector	cable connector	connector cable	cable connector	cable connector
housing material	plastic	plastic	plastic	metal	metal
page	432	434	436	438	440



General information

Diffuse contrast sensors can detect finest differences in contrast. Contrasts arise when surfaces bear bright and dark areas (e.g. a dark color mark on a bright primary color), or by structures on a surface (e.g. a weld seam).

Applications

- Recognize print marks (FKDK 14)
Print marks (or color marks) are usually dark-colored marks on a light background. The marks differ from the background in brightness and often in color.
- Detect edges, seams, grooves (laser sensors)
If a surface is observed from an oblique angle, the reflection behavior changes at an indentation, which to the sensor is equivalent to a contrast difference.

Characteristics and advantages

- White light sensor
The narrow white light line allows precise detection of color marks
- Laser sensors
Thanks to the focused beam, even the slightest edge up to 0.1 mm in height can be detected.
- Fast response time
Very short response times up to 50 μ s allow "real time" recording of marks and thus increase the process accuracy.
- Sensor with analog signal
Allows to import desired nominal values and to detect deviations thereof.

Technology and operation

Diffuse contrast sensors are based on the intensity difference principle with a clearly defined small light spot. At the ideal operating distance the sensor is optimized so that the finest contrast differences are detected almost independent of small changes in distance. The graph "Relative signal reception" was measured on white paper.

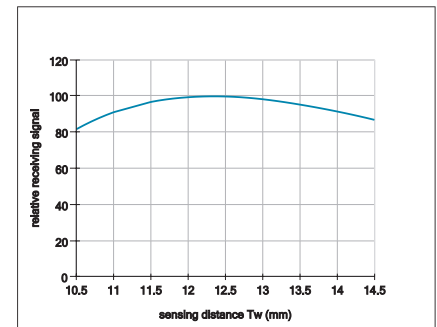

Mounting and adjustment

The sensor should usually be mounted inclined by 5° to 20° to the object surface, especially when shiny material is scanned. When scanning edges, grooves or indentations, the sensor must be aligned so that the direct reflection is detected when the indentation, groove, or edge enters the light beam.

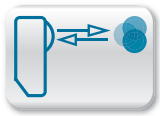

$T_w = 12.5 \text{ mm}$



- hygiene design
- very short response time
- White light

general data

type	diffuse contrast sensor
special type	hygienic design
light source	white LED
sensing distance T_w	12,5 mm \pm 2 mm
light indicator	LED green
output indicator	LED yellow
sensitivity adjustment	Teach-in
distance to focus	12,5 mm
beam height	3 mm
beam width	1 mm
approvals/certificates	Ecolab EHEDG

electrical data

response time / release time	< 0,05 ms
voltage supply range +Vs	18 ... 30 VDC
current consumption max. (no load)	50 mA
current consumption typ.	40 mA
voltage drop Vd	< 3 VDC
output function	light / dark operate
output circuit	push-pull
output current	< 100 mA
short circuit protection	yes
reverse polarity protection	yes

mechanical data

width / diameter	19,6 mm
height / length	52,2 mm
depth	34,3 mm
type	rectangular
housing material	stainless steel 1.4404 (V4A)
front (optics)	PMMA

ambient conditions

operating temperature	-25 ... +60 °C
protection class	IP 68/69K & proTect+

order reference

FKDH 14G6901	cable 4 pin, 2 m
FKDH 14G6901/KS34A	flylead connector M12, L=300 mm

connection types

connection diagram

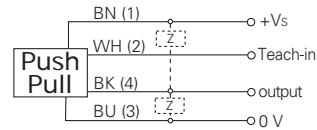

connectors and mating connectors

ESG 34AY0200 Connector M12, 4 pin, straight, 2 m, V4A-PP

ESW 33AY0200 Connector M12, 4 pin, angular, 2 m, V4A-PP

additional cable connectors and field wireable connectors: see accessories

Accessories

HI17-1H Mounting for sensors in hygienic design \varnothing 17 mm
for details: see accessories section

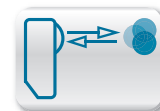

relative receiving signal

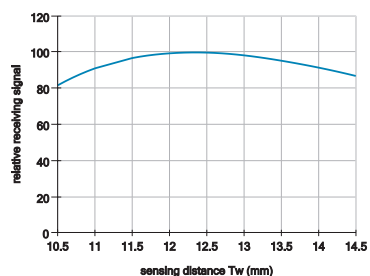

dimension drawings

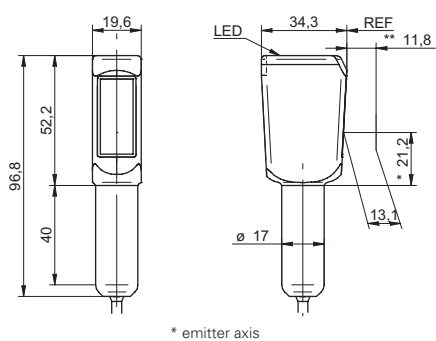

* emitter axis

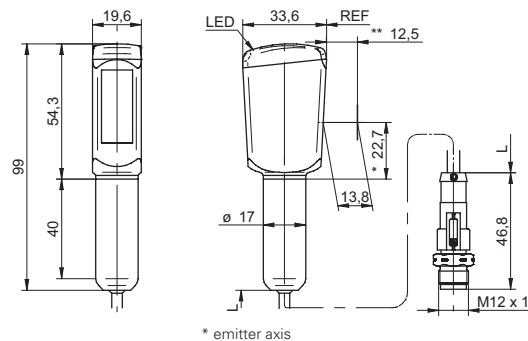

* emitter axis

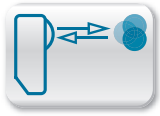

Tw = 12.5 mm

- very short response time
- white light

**general data**

type	diffuse contrast sensor
light source	white LED
sensing distance Tw	12,5 mm ±2 mm
light indicator	LED green
output indicator	LED yellow
sensitivity adjustment	Teach-in
distance to focus	12,5 mm
beam height	3 mm
beam width	1 mm

electrical data

response time / release time	< 0,05 ms
voltage supply range +Vs	18 ... 30 VDC
current consumption max. (no load)	50 mA
current consumption typ.	40 mA
voltage drop Vd	< 3 VDC
output function	light / dark operate
output circuit	push-pull
output current	< 100 mA
short circuit protection	yes
reverse polarity protection	yes

mechanical data

width / diameter	14,8 mm
height / length	43 mm
depth	31 mm
type	rectangular
housing material	plastic (ASA, MABS)
front (optics)	PMMA

ambient conditions

operating temperature	-25 ... +65 °C
protection class	IP 67

order reference

order reference	connection types
FKDK 14G6901	cable 4 pin, 2 m
FKDK 14G6901/S14	connector M12 4 pin
FKDK 14G6901/S35A	connector M8 4 pin

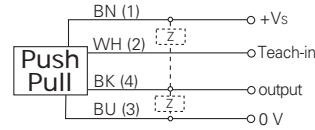
connection diagram**connectors and mating connectors**

ESG 34AH0200	Connector M12, 4 pin, straight, 2 m
ESW 33AH0200	Connector M12, 4 pin, angular, 2 m
ESG 32AH0200	Connector M8, 4 pin, straight, 2 m
ESW 31AH0200	Connector M8, 4 pin, angular, 2 m

additional cable connectors and field wireable connectors: see accessories

Accessories

10134964	Mounting bracket series 14 (L design)
10149011	Sensofix series 14

for details: see accessories section

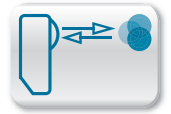

relative receiving signal

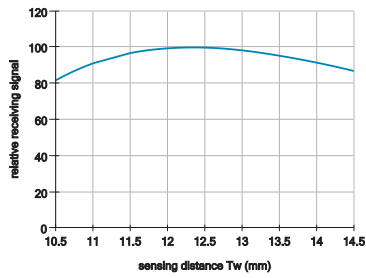

dimension drawings

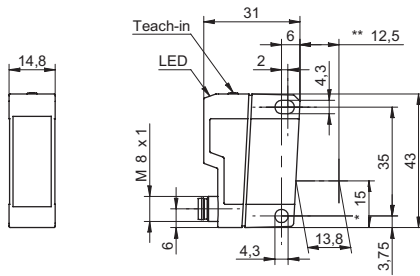

* emitter axis

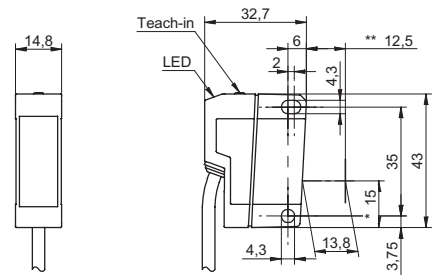

* emitter axis

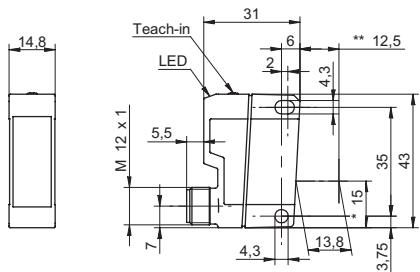

* emitter axis

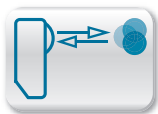

Tw = 12.5 mm



- washdown design
- very short response time
- White light

general data

type	diffuse contrast sensor
special type	Washdown design
light source	white LED
sensing distance Tw	12,5 mm ±2 mm
light indicator	LED green
output indicator	LED yellow
sensitivity adjustment	Teach-in
distance to focus	12,5 mm
beam height	3 mm
beam width	1 mm
approvals/certificates	Ecolab

electrical data

response time / release time	< 0,05 ms
voltage supply range +Vs	18 ... 30 VDC
current consumption max. (no load)	50 mA
current consumption typ.	40 mA
voltage drop Vd	< 3 VDC
output function	light / dark operate
output circuit	push-pull
output current	< 100 mA
short circuit protection	yes
reverse polarity protection	yes

mechanical data

width / diameter	19,6 mm
height / length	51 mm
depth	34,3 mm
type	rectangular
housing material	stainless steel 1.4404 (V4A)
front (optics)	PMMA
connection types	connector M12

ambient conditions

operating temperature	-25 ... +60 °C
protection class	IP 68/69K & proTect+

order reference

FKDR 14G6901/S14

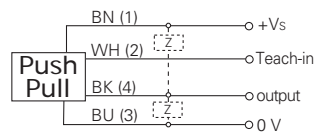
connection diagram**Accessories**

10134964	Mounting bracket series 14 (L design)
10149011	Sensofix series 14

for details: see accessories section

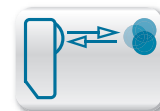

relative receiving signal

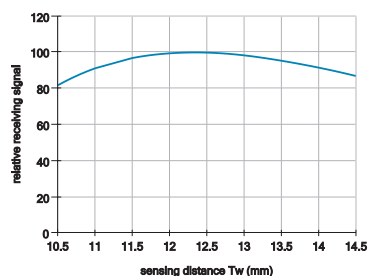

dimension drawing

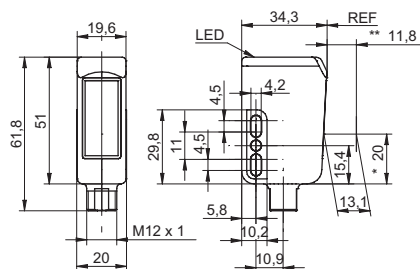

* emitter axis

FKDR 14 Tw = 12.5 mm

Diffuse contrast sensors

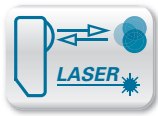

Tw = 3 ... 150 mm

- compact housing
- high repeatability
- very short response time



general data

type	diffuse contrast sensor
version	line beam
light source	pulsed red laser diode
sensing distance Tw	3 ... 150 mm
optimum operating distance	35 ... 45 mm
repeat accuracy	< 0,2 mm at laser focus
power on indication	LED green
light indicator	LED yellow
sensitivity adjustment	potentiometer, 5 turn
laser class	1
distance to focus	40 mm
wave length	650 nm

electrical data

response time / release time	< 0,05 ms
voltage supply range +Vs	10 ... 30 VDC
current consumption max. (no load)	50 mA
current consumption typ.	40 mA
voltage drop Vd	< 1,8 VDC
output function	light / dark operate
output current	< 100 mA
short circuit protection	yes
reverse polarity protection	yes

mechanical data

width / diameter	10,4 mm
height / length	27 mm
depth	16,3 mm
type	rectangular
housing material	plastic (ASA)
front (optics)	PMMA

ambient conditions

operating temperature	-10 ... +50 °C
-----------------------	----------------

connection diagrams



connectors and mating connectors

ESG 32AH0200	Connector M8, 4 pin, straight, 2 m
ESW 31AH0200	Connector M8, 4 pin, angular, 2 m

additional cable connectors and field wireable connectors: see accessories

Accessories

10150326	Sensofix series 10 / series 20
10114501	Mounting bracket series 10 (U design)
10133792	Mounting bracket series 10 (L design)
10162083	Mounting panel for sensors series 10
10118798	Mounting bracket series 10

for details: see accessories section

laser warning



IEC 60825-1/2014
Complies with 21 CFR 1040.10 and 1040.11
except for deviations pursuant to laser
notice No. 50, dated June 24, 2007

order reference	connection types	output circuit	protection class
OZDK 10N5150	cable 4 pin, 2 m	NPN	IP 65
OZDK 10N5150/S35A	connector M8 4 pin	NPN	IP 67
OZDK 10P5150	cable 4 pin, 2 m	PNP	IP 65
OZDK 10P5150/S35A	connector M8 4 pin	PNP	IP 67

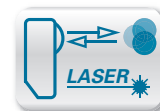

relative receiving signal

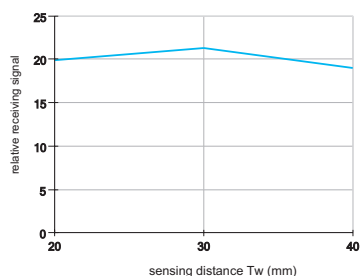

beam characteristic (typically)

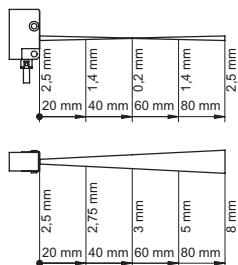

dimension drawings

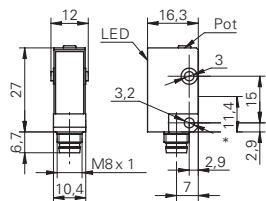

* emitter axis

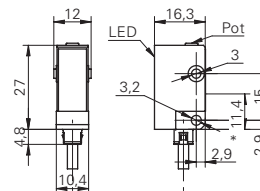

* emitter axis

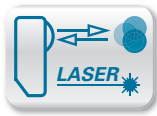

Tw = 3 ... 150 mm

- compact housing
- high repeatability
- very short response time



general data

type	diffuse contrast sensor
light source	pulsed red laser diode
sensing distance Tw	3 ... 150 mm
optimum operating distance	20 ... 40 mm
detectable remission difference (on grey)	> 8 %
repeat accuracy	< 0,2 mm at laser focus
power on indication	LED green
light indicator	LED yellow
sensitivity adjustment	potentiometer, 5 turn
laser class	2
distance to focus	40 mm
wave length	650 nm

electrical data

response time / release time	< 0,05 ms
voltage supply range +Vs	10 ... 30 VDC
current consumption max. (no load)	50 mA
current consumption typ.	40 mA
voltage drop Vd	< 1,8 VDC
output function	light / dark operate
output current	< 100 mA
short circuit protection	yes
reverse polarity protection	yes

mechanical data

width / diameter	10,4 mm
height / length	27 mm
depth	16,3 mm
type	rectangular
housing material	plastic (ASA)
front (optics)	PMMA

ambient conditions

operating temperature	-10 ... +50 °C
-----------------------	----------------

connection diagrams



connectors and mating connectors

ESG 32AH0200	Connector M8, 4 pin, straight, 2 m
ESW 31AH0200	Connector M8, 4 pin, angular, 2 m

additional cable connectors and field wireable connectors: see accessories

Accessories

10150326	Sensofix series 10 / series 20
10114501	Mounting bracket series 10 (U design)
10133792	Mounting bracket series 10 (L design)
10162083	Mounting panel for sensors series 10
10118798	Mounting bracket series 10

for details: see accessories section

laser warning

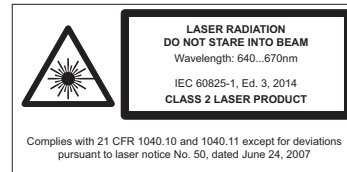

Complies with 21 CFR 1040.10 and 1040.11 except for deviations pursuant to laser notice No. 50, dated June 24, 2007

order reference	connection types	output circuit	protection class
OZDK 10N5101	cable 4 pin, 2 m	NPN	IP 65
OZDK 10N5101/S35A	connector M8 4 pin	NPN	IP 67
OZDK 10P5101	cable 4 pin, 2 m	PNP	IP 65
OZDK 10P5101/S35A	connector M8 4 pin	PNP	IP 67

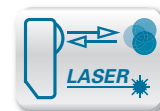

relative receiving signal

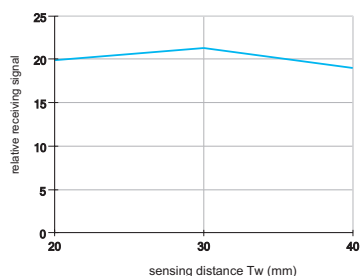

beam characteristic (typically)

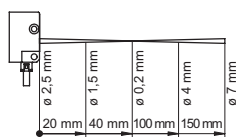

dimension drawings

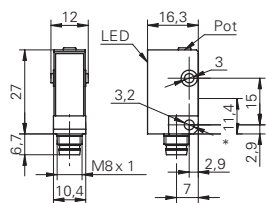

* emitter axis

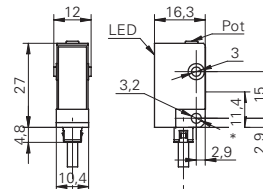

* emitter axis

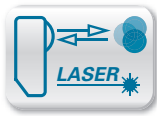

$T_w = 20 \dots 300 \text{ mm}$

- very short response time
- high repeatability
- sensing distance adjustable via Teach-in



general data

type	diffuse contrast sensor
light source	pulsed red laser diode
sensing distance T_w	20 ... 300 mm
optimum operating distance	40 ... 60 mm
repeat accuracy	< 0,2 mm at laser focus
alignment / soiled lens indicator	flashing light indicator
power on indication	LED green
light indicator	LED yellow
sensitivity adjustment	Teach-in
laser class	2
distance to focus	115 mm
wave length	650 nm

electrical data

response time / release time	< 0,15 ms
voltage supply range +Vs	10 ... 30 VDC
current consumption max. (no load)	35 mA
current consumption typ.	25 mA
voltage drop Vd	< 2,2 VDC
output function	light operate
output current	< 100 mA
short circuit protection	yes
reverse polarity protection	yes

mechanical data

width / diameter	14,8 mm
height / length	43 mm
depth	31 mm
type	rectangular
housing material	plastic (ASA, MABS)
front (optics)	PMMA

ambient conditions

operating temperature	-10 ... +50 °C
protection class	IP 67

connection diagrams



connectors and mating connectors

ESG 34AH0200	Connector M12, 4 pin, straight, 2 m
ESW 33AH0200	Connector M12, 4 pin, angular, 2 m
ESG 32AH0200	Connector M8, 4 pin, straight, 2 m
ESW 31AH0200	Connector M8, 4 pin, angular, 2 m

additional cable connectors and field wireable connectors: see accessories

Accessories

10149011	Sensofix series 14
10134964	Mounting bracket series 14 (L design)

for details: see accessories section

laser warning

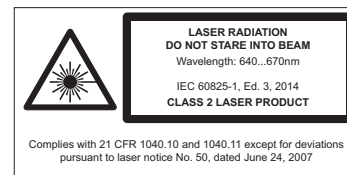

order reference	connection types	output circuit
OZDK 14N1901/S14	connector M12 4 pin	NPN
OZDK 14P1901	cable 4 pin, 2 m	PNP
OZDK 14P1901/S14	connector M12 4 pin	PNP
OZDK 14P1901/S35A	connector M8 4 pin	PNP

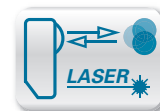

relative receiving signal

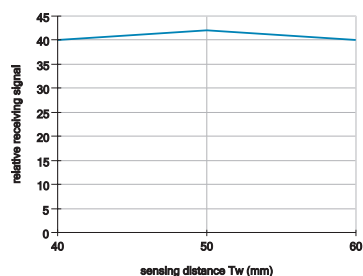

beam characteristic (typically)

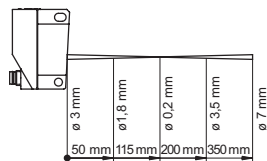

dimension drawings

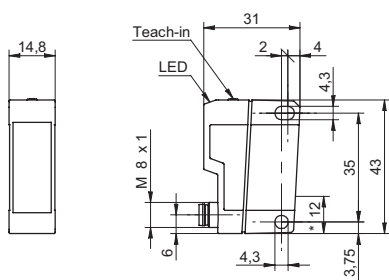

* emitter axis

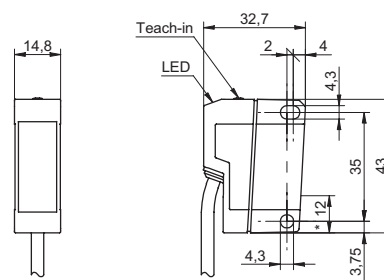

* emitter axis

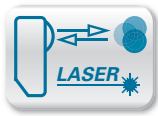

Tw = 0 ... 250 mm

- with analog output
- high repeatability
- very short response time



general data

type	diffuse contrast sensor
light source	pulsed red laser diode
sensing distance Tw	0 ... 250 mm
optimum operating distance	40 ... 80 mm
detectable remission difference (on grey)	> 8 %
repeat accuracy	< 0,1 mm at laser focus
output indicator	LED yellow
sensitivity adjustment	potentiometer, 14 turn
laser class	1
distance to focus	80 mm
wave length	650 nm

electrical data

response time / release time	< 0,1 ms
voltage supply range +Vs	12 ... 30 VDC
current consumption max. (no load)	65 mA
current consumption typ.	60 mA
voltage drop Vd	< 2 VDC
output function	light operate
output circuit	PNP / analog 4 ... 20 mA
output current	< 200 mA
short circuit protection	yes
reverse polarity protection	yes

mechanical data

width / diameter	15,4 mm
height / length	50 mm
depth	50 mm
type	rectangular
housing material	die-cast zinc
front (optics)	glass

ambient conditions

operating temperature	-10 ... +50 °C
protection class	IP 67

order reference

order reference	connection types
OZDM 16P1901	cable 4 pin, 2 m
OZDM 16P1901/S14	connector M12 4 pin

connection diagram

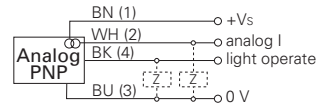

connectors and mating connectors

ESG 34AH0200 Connector M12, 4 pin, straight, 2 m

ESW 33AH0200 Connector M12, 4 pin, angular, 2 m

additional cable connectors and field wireable connectors: see accessories

Accessories

10151721 Sensofix series 16

10113917 Mounting bracket series 16 (L design)

for details: see accessories section

laser warning

**CLASS 1 LASER
PRODUCT**

IEC 60825-1/2014

Complies with 21 CFR 1040.10 and 1040.11
except for deviations pursuant to laser
notice No. 50, dated June 24, 2007

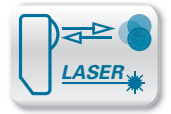

signal progression

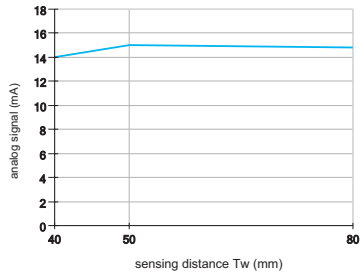

beam characteristic (typically)

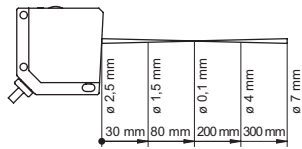

dimension drawings

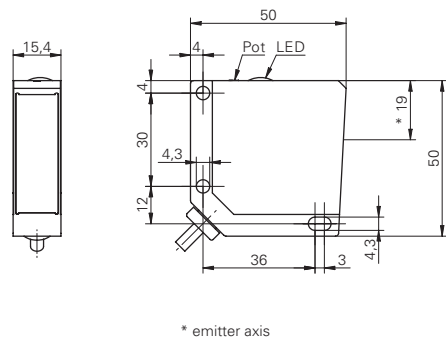
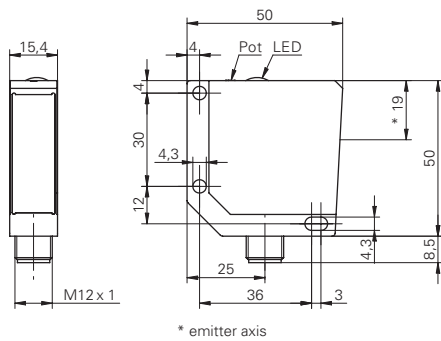

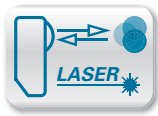

Tw = 0 ... 250 mm



- rugged metal housing
- high repeatability
- very short response time

general data

type	diffuse contrast sensor
light source	pulsed red laser diode
sensing distance Tw	0 ... 250 mm
optimum operating distance	40 ... 80 mm
detectable remission difference (on grey)	> 8 %
repeat accuracy	< 0,1 mm at laser focus
output indicator	LED yellow
sensitivity adjustment	potentiometer, 14 turn
laser class	1
distance to focus	80 mm
wave length	650 nm

electrical data

response time / release time	< 0,05 ms
voltage supply range +Vs	12 ... 30 VDC
current consumption max. (no load)	65 mA
current consumption typ.	60 mA
voltage drop Vd	< 2 VDC
output current	< 200 mA
short circuit protection	yes
reverse polarity protection	yes

mechanical data

width / diameter	15,4 mm
height / length	50 mm
depth	50 mm
type	rectangular
housing material	die-cast zinc
front (optics)	glass

ambient conditions

operating temperature	-10 ... +50 °C
protection class	IP 67

connection diagrams

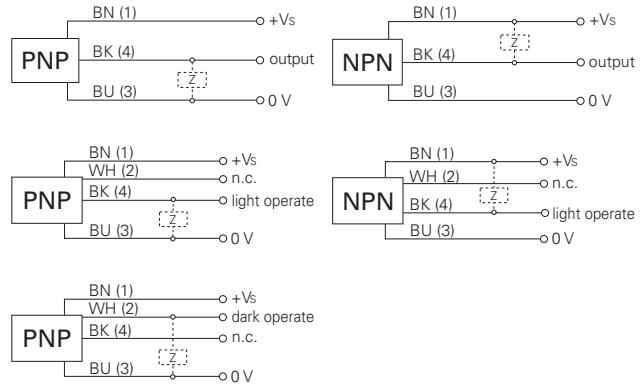

connectors and mating connectors

ESG 34AH0200	Connector M12, 4 pin, straight, 2 m
ESW 33AH0200	Connector M12, 4 pin, angular, 2 m

additional cable connectors and field wireable connectors: see accessories

Accessories

10151721	Sensofix series 16
10113917	Mounting bracket series 16 (L design)

for details: see accessories section

laser warning



IEC 60825-1/2014
Complies with 21 CFR 1040.10 and 1040.11
except for deviations pursuant to laser
notice No. 50, dated June 24, 2007

order reference	connection types	output circuit	output function
OZDM 16N1001	cable 3 pin, 2 m	NPN	light operate
OZDM 16N1001/S14	connector M12 4 pin	NPN	light operate
OZDM 16P1001	cable 3 pin, 2 m	PNP	light operate
OZDM 16P1001/S14	connector M12 4 pin	PNP	light operate
OZDM 16P3001	cable 3 pin, 2 m	PNP	dark operate
OZDM 16P3001/S14	connector M12 4 pin	PNP	dark operate

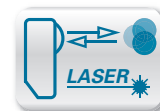

relative receiving signal

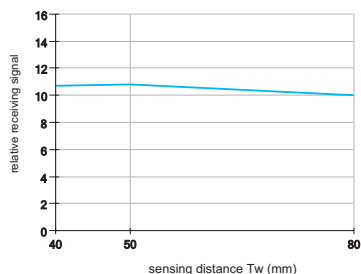

beam characteristic (typically)

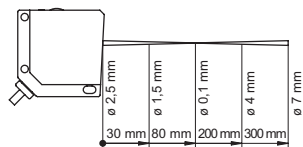

dimension drawings

